

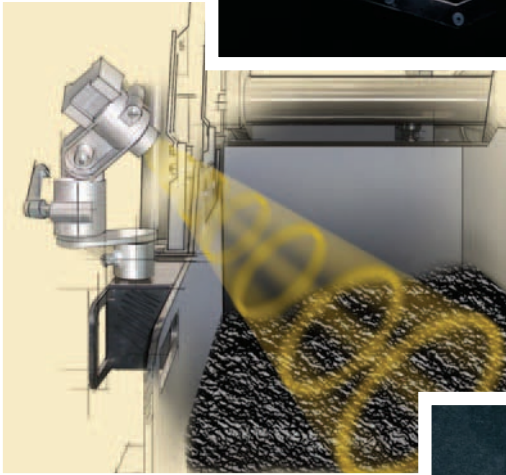

Titan 125

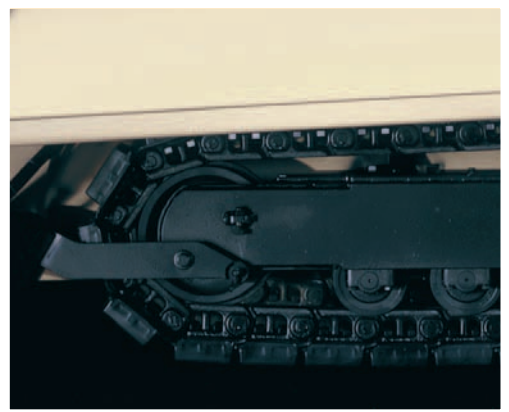





VB 30
min 1.5 m max 4 m

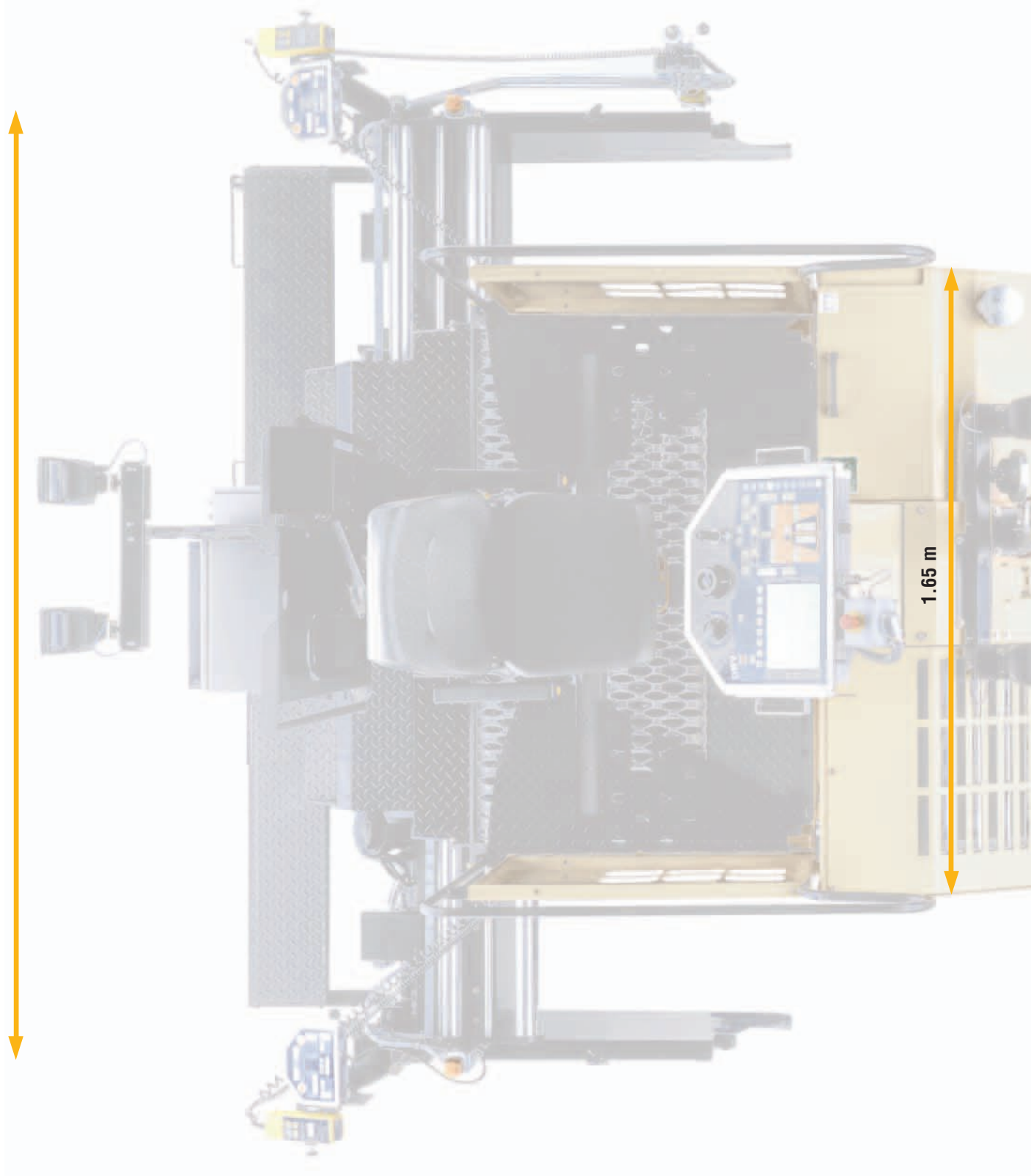

5.03 m

VB 30

1.5 - 3.0 m = 9.5 t

- 4.0 m = 9.75 t

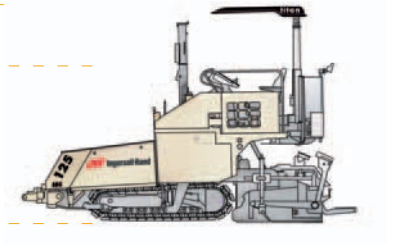

max 330 t/h
max 29 m/min



max 250 mm



max 6 km/h

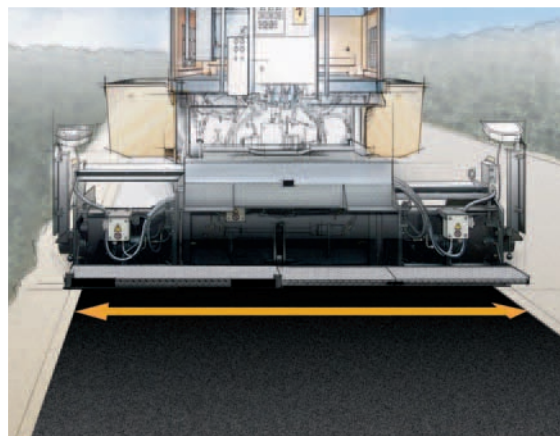
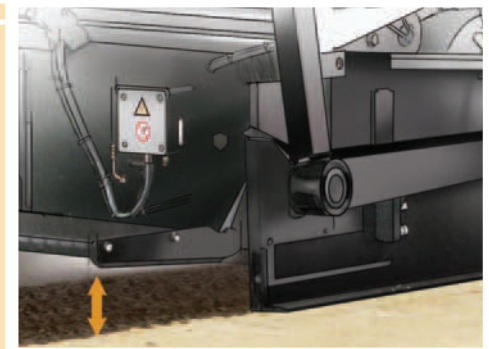

1.5 - 4 m

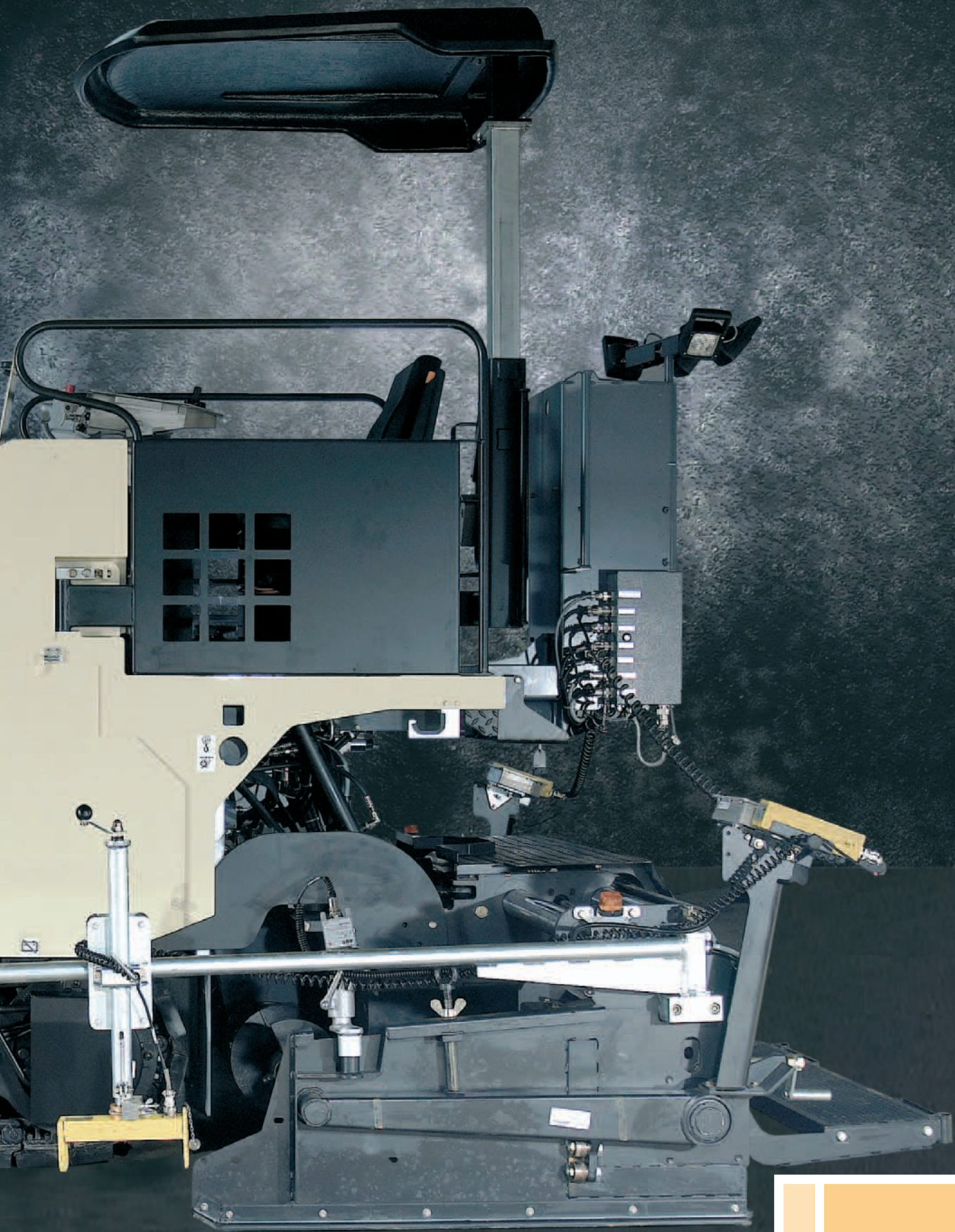

Titan 125

Technische Änderungen vorbehalten.
Specifications are subject to alteration without prior notice.
Sous réserve de modifications techniques.
Nos reservamos el derecho de realizar modificaciones técnicas sin previo aviso.

© 2005 IR-ABG Form # 20 - 0705 CPN 80624893

 **Ingersoll-Rand**

ABG

Allgemeine Baumaschinen-
Gesellschaft mbH
Kuhbrückenstraße 18
31785 Hameln
www.ir-abg.com